



**From A to Zabbix
with zero effort**

\$ whoami



@RaymondKuiper



nl.linkedin.com/in/raymondkuiper



github.com/q1x



NETCO®

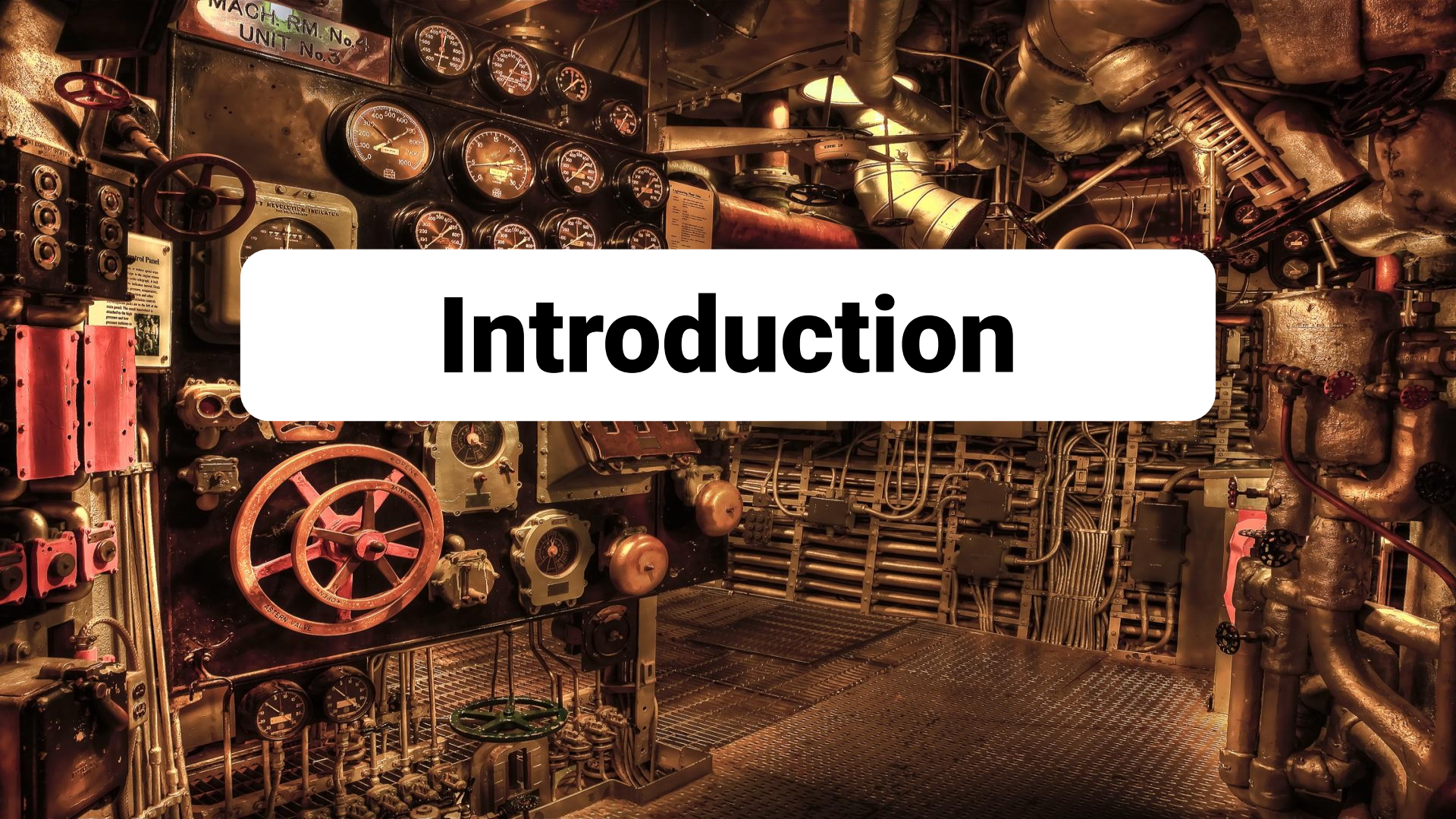

Introduction



NETCO®





RETAILSTEKKER

Uw retailverbinding





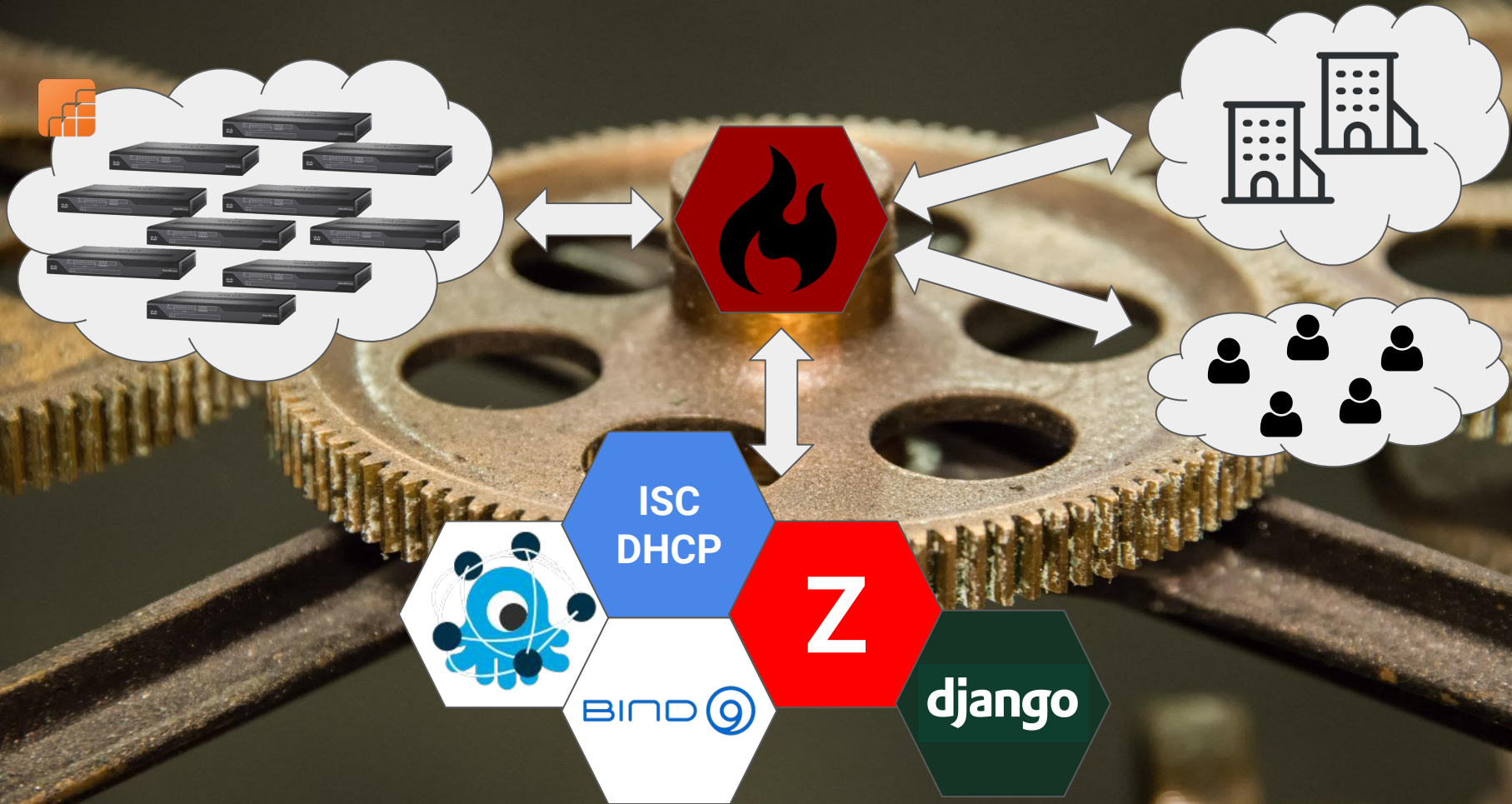

248
OP VASTE LIJN



15
OP 4G



2
OFFLINE



0
GEPLAND



5
ONBEKEND



TICKETS

TICKET NR

OMSCHRIJVING

STATUS

Kies een locatie

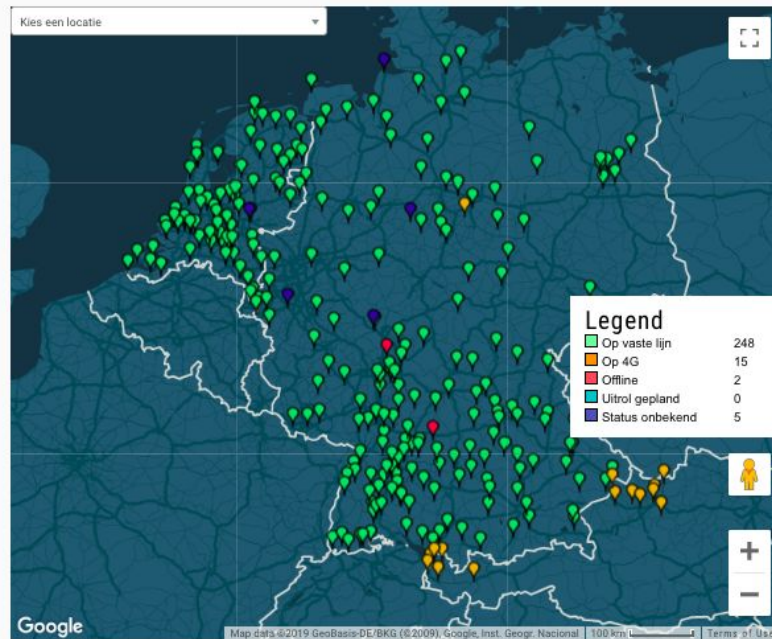

Google

Map data ©2019 GeoBasis-DE/BKG (©2009), Google, Inst. Geogr. Nacional | 100 km | Terms of Use

volledig scherm

DASHBOARDS ×

WINKELS

LOCATIES

LIJNAANVRAGEN

VOORKEUREN

ADMIN

ALERTING

LOGOUT

HISTOGRAM

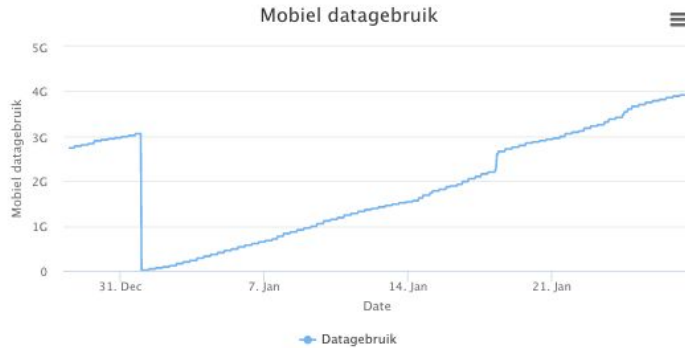
LATENCY(24H) LATENCY(30D) PACKETLOSS(24H) PACKETLOSS(30D) AVAILABILITY(24H)
AVAILABILITY(30D) MOBILE DATA(24H) **MOBILE DATA(20D)**

INFO

ALGEMEEN DSL MOBIEL

Verbinding status: onbackup
Actieve verbinding: Cellular
Lokaal subnet: 10.3.6.0/24

TOOLS

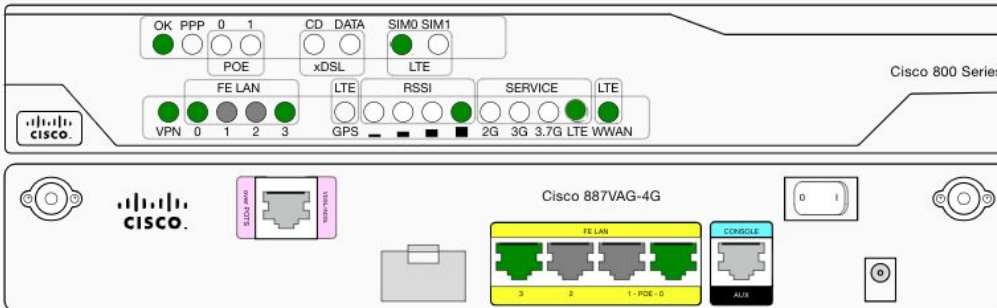
[START DIAGNOSE VASTE VERBINDING](#)[LED STATUS ROUTER OPVRAGEN](#)[ROUTER HERSTARTEN](#)

DASHBOARDS ×

WINKELS

DERDE PARTIJEN

KANTOREN

🏠 LOCATIES

✉ LIJNAANVRAGEN

⚙ VOORKEUREN

⚙ ADMIN

⚙ ALERTING

🔑 LOGOUT
(BAWMOHON@NETCO.NL)

DERDE PARTIJEN

HOME / DERDE PARTIJEN

13

OK



0

WARNING



6

PROBLEM



DERDE PARTIJEN KOPPELINGEN

#	NAAM	OPMERKINGEN	CONTACTPERSOON	STATUS
1	✓
2	✓
3	!
4	✓
5	!
6	!
7	M.E.E.	...		✓

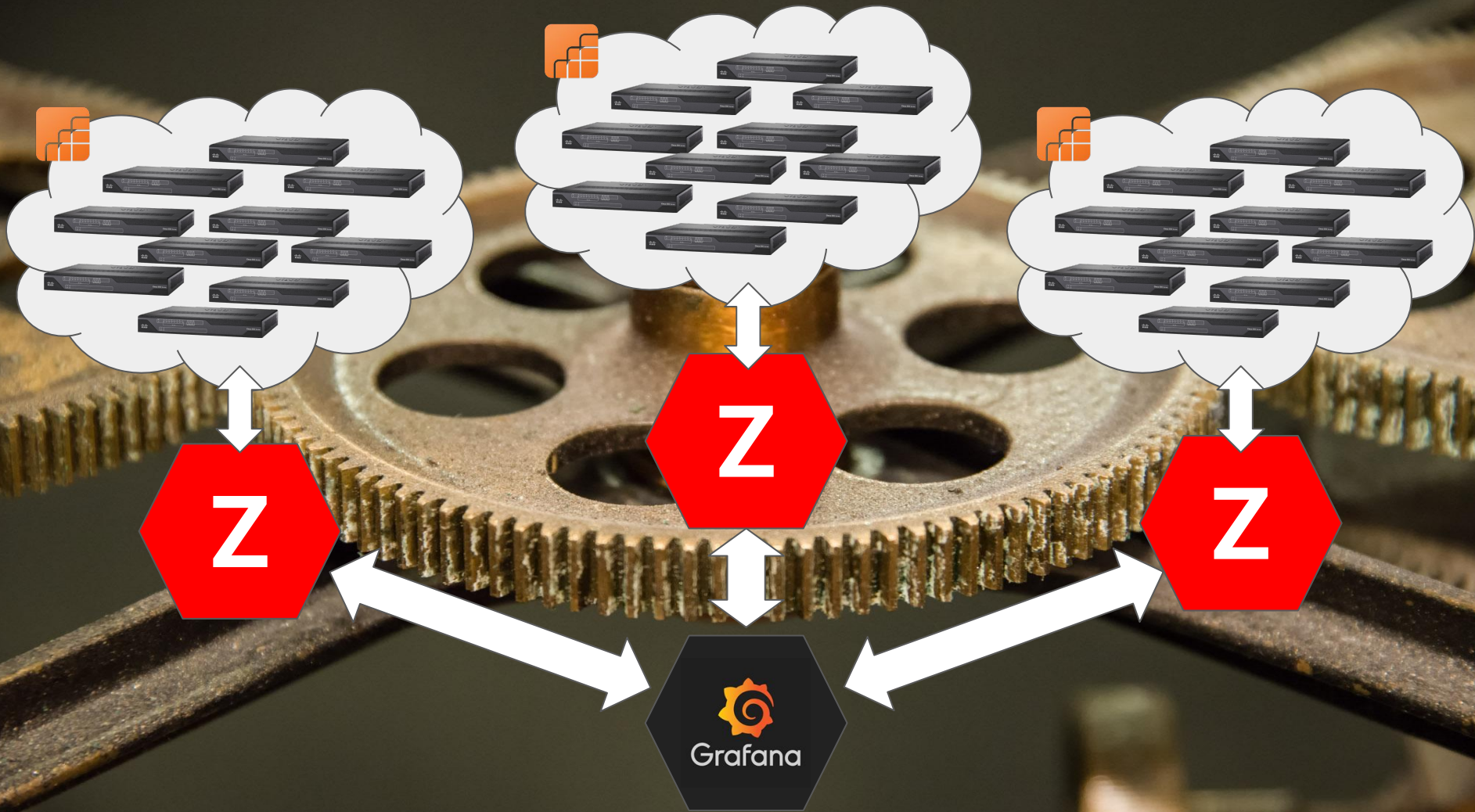

RetailStekker

	1	2	3	4	5	6	7	8	9	10
AVERAGE VPN	516	95	17	174	378	21	183	1	7	0
ACTIVE VPN	516	95	16	174	378	21	183	1	7	0
MAINTENANCE/OFF-LINE VPN	1.7	11	2	7	1	0	15	177	0	3

Unacknowledged Triggers

- 
Cellular: Backup Interface is active
Warning for 22 minutes
18 Sep 2019 08:38:07
- 
Ping: [redacted] is not responding to requests
Average for 2 hours
18 Sep 2019 07:17:27
- 
Ping: [redacted] is not responding to requests
Average for 8 hours
18 Sep 2019 01:27:44
- 
Zabbix: Unreachable poller process is more than 80% busy
Average for a day
17 Sep 2019 11:28:54
- 
Ping: [redacted] is not responding to requests
Average for a day
17 Sep 2019 00:18:45
- 
Ping: [redacted] is not responding to requests
Average for a day
17 Sep 2019 00:18:43

	FR	DE	IT	ES	UK	US	FR	DE	IT
Hosts	545	118	24	198	407	47	357	12	8
Items (enabled)	71544	11538	1918	1918	41330	3119	7094	929	188
Items (unsupported)	993	636	137	1457	2669	239	727	64	33
NVPS (required)	302	44	9	104	182	14	33	4	1.0
Poller	79%	48%	3%	37%	55%	4%	34%	1.7%	0.48%
Poller (unreachable)	17%	23%	4.5%	17%	31%	0.16%	100%	0.016%	5.4%
Pinger	13%	5.8%	1.5%	6%	10%	3%	8%	0.59%	0.4%
Hist Syncer	42%	0.6%	0.3%	7%	27%	0.2%	0.3%	0.08%	0.04%
Housekeeper	100%	18%	1.9%	37%	100%	1.7%	9%	1.0%	8%
Config Cache (free)	49%	90%	98%	81%	69%	98%	88%	99%	78%
Value Cache (free)	85%	97%	97%	100%	95%	93%	99%	100%	100%



Installation

MACH. RM. No. 4
UNIT No. 3

REVOLUTION INDICATOR

ASTERY VALVE

COLE 2

Control Panel



Customer

Please specify customer parameters.

Name: Demo
Environment: 15
Domain: demo.local

- Primary vmhost
- vmhost012.
 - vmhost013.
 - vmhost014.
 - vmhost015.

- Secondary vmhost
- vmhost012.
 - vmhost013.
 - vmhost014.
 - vmhost015.

- Deploy monitoring on..
- Primary
 - Secondary

Cancel OK

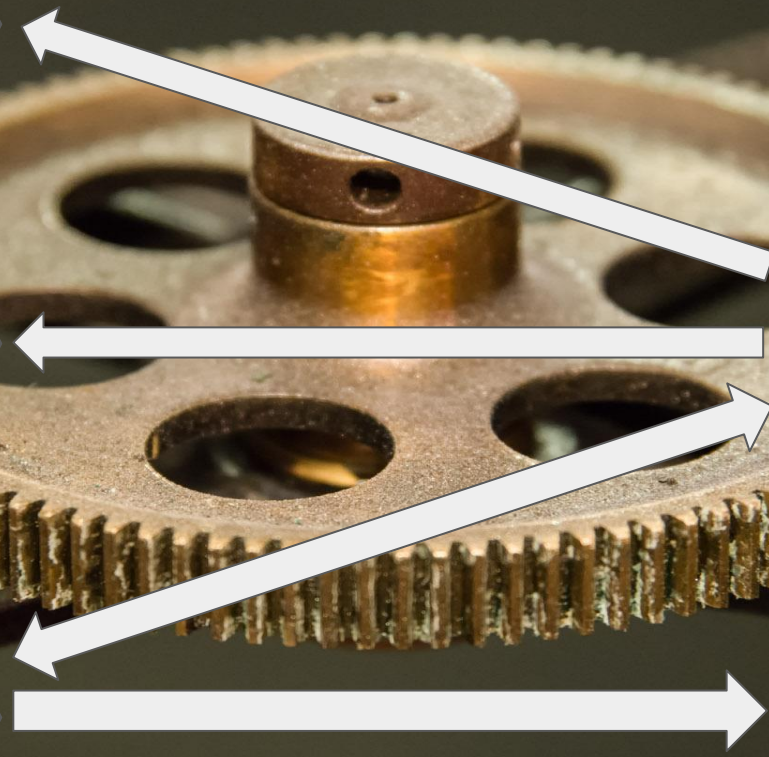
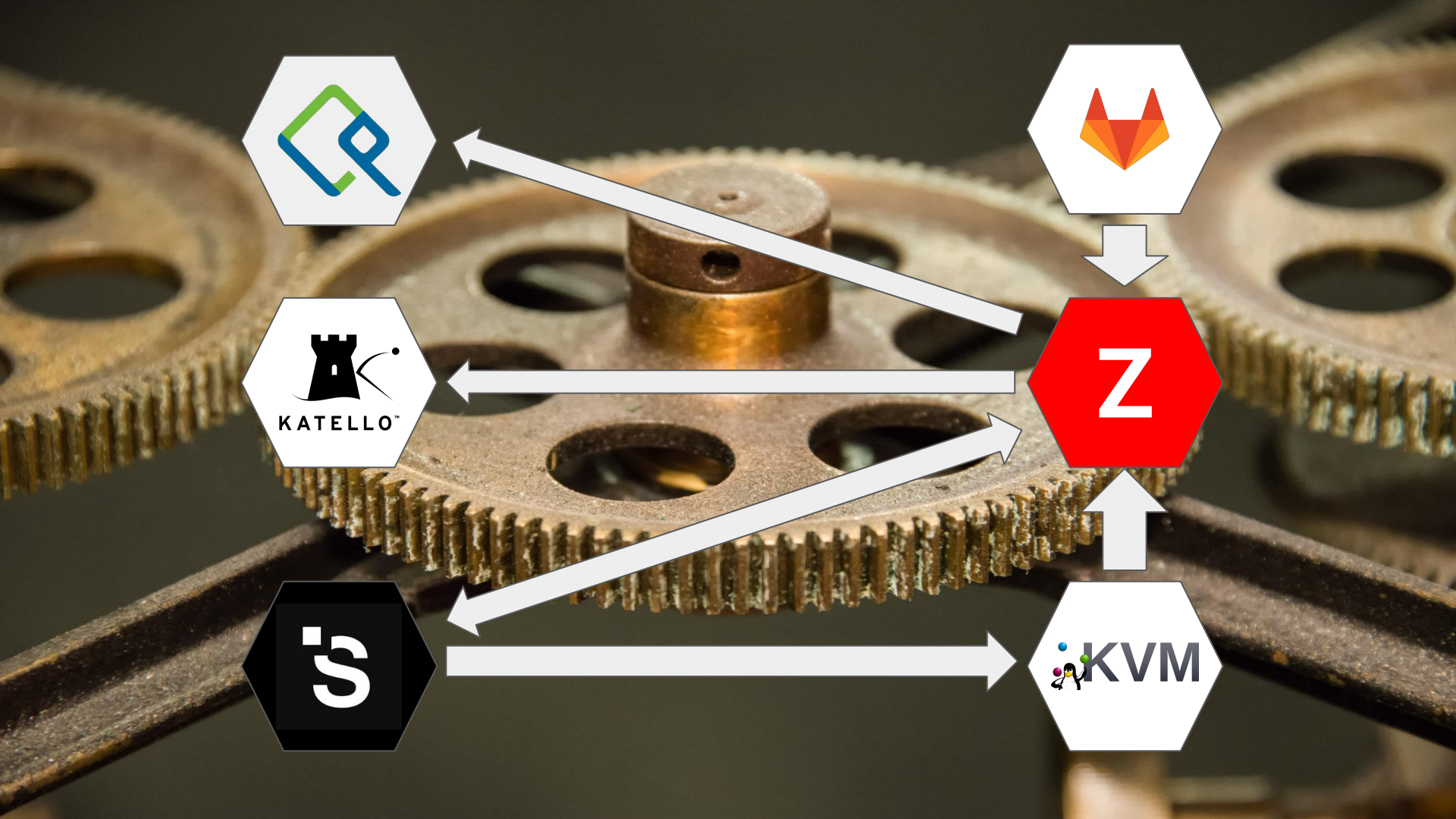



Configuration

LDAP Auth

enable Zabbix ldap auth:

mysql_query.run:

- database: zabbix
- query: "UPDATE config SET authentication_type=1,
ldap_host='ldap://{{ ldap.host }}', ldap_port={{ ldap.port }},
ldap_base_dn='{{ ldap.basedn }}', ldap_bind_dn='{{ ldap.binddn }}',
ldap_bind_password='{{ ldap.password }}',
ldap_search_attribute='{{ ldap.search }}'"

Can we get some love for ZBXNEXT-4268?



Media

```
$ cat /srv/salt/zabbix-server/mediatypes.sls
```

```
...  
Zabbix email mediatype:  
  zabbix_mediatype.present:  
    - name: 'Email'  
    - mediatype: 0  
    - smtp_server: localhost  
    - smtp_helo: {{ salt['grains.get']('id','localhost') }}  
    - smtp_email: 'zabbix@example.com'  
...
```

User Groups

Zabbix Admin groups

zabbix.adm_usergroups:

- Support
- API

Zabbix User groups

zabbix.usr_usergroups:

- Users

LDAP users

```
$ cat /srv/salt/zabbix-server/users.sls
{%- for username in salt['cmd.run']("getent group \
                                     'grp-zabbix-users'").split(':')[3].split(',') %}
Zabbix user {{ username }}:
  zabbix_user.present:
    - alias: '{{ username }}'
    - passwd: ''
    - password_reset: False
    - usrgrps:
      - Support
    - medias:
      - mediatypeid: {{ salt['zabbix.mediatype_get'](name='Email') }}
      - sendto: '{{ username }}@example.com'
      - active: 0
      - severity: 63
      - period: '1-7,00:00-24:00'
{%- endfor %}
```

External Scripts

```
$ cat /srv/salt/zabbix-server/scripts.sls
...
external-scripts:
  git.latest:
    - name: https://gitlab.local/zabbix/external-scripts.git
    - target: /opt/zabbix/scripts/external
    - force_reset: True
    - require:
      - pkg: git
...
```

Template Sync

```
$ cat /srv/salt/zabbix-server/templates.sls
```

```
...
```

```
templates:
```

```
  file.directory:
```

- name: /opt/zabbix/templates/

```
  git.latest:
```

- name: https://gitlab.local/zabbix/templates.git
- target: /opt/zabbix/templates/
- require:
- pkg: git

```
  cmd.run:
```

- name: /opt/zabbix/scripts/template-import.py -v -T /opt/zabbix/templates/
- runas: zabbix
- onchanges:
- git: templates



Managing Hosts

Hostgroups

Zabbix Default groups

zabbix.dft_hostgroups:

- Aggregates
- Predeployment
- Maintenance
- Offline
- Netco Managed
- 3rd Parties
- Branches
- Servers

Zabbix Device groups

zabbix.dev_hostgroups:

- Switches
- Accesspoints
- Routers
- Phones

Create Hosts

Monitored Hosts

```
zabbix.hosts:
```

- name: google-public-dns-a.google.com
label: Google DNS1
ip: 8.8.8.8
groups:
 - 3rd Parties
- ```
macros:
 - '{$TIMEOUT}': 180template: "t_availability_ping"
```



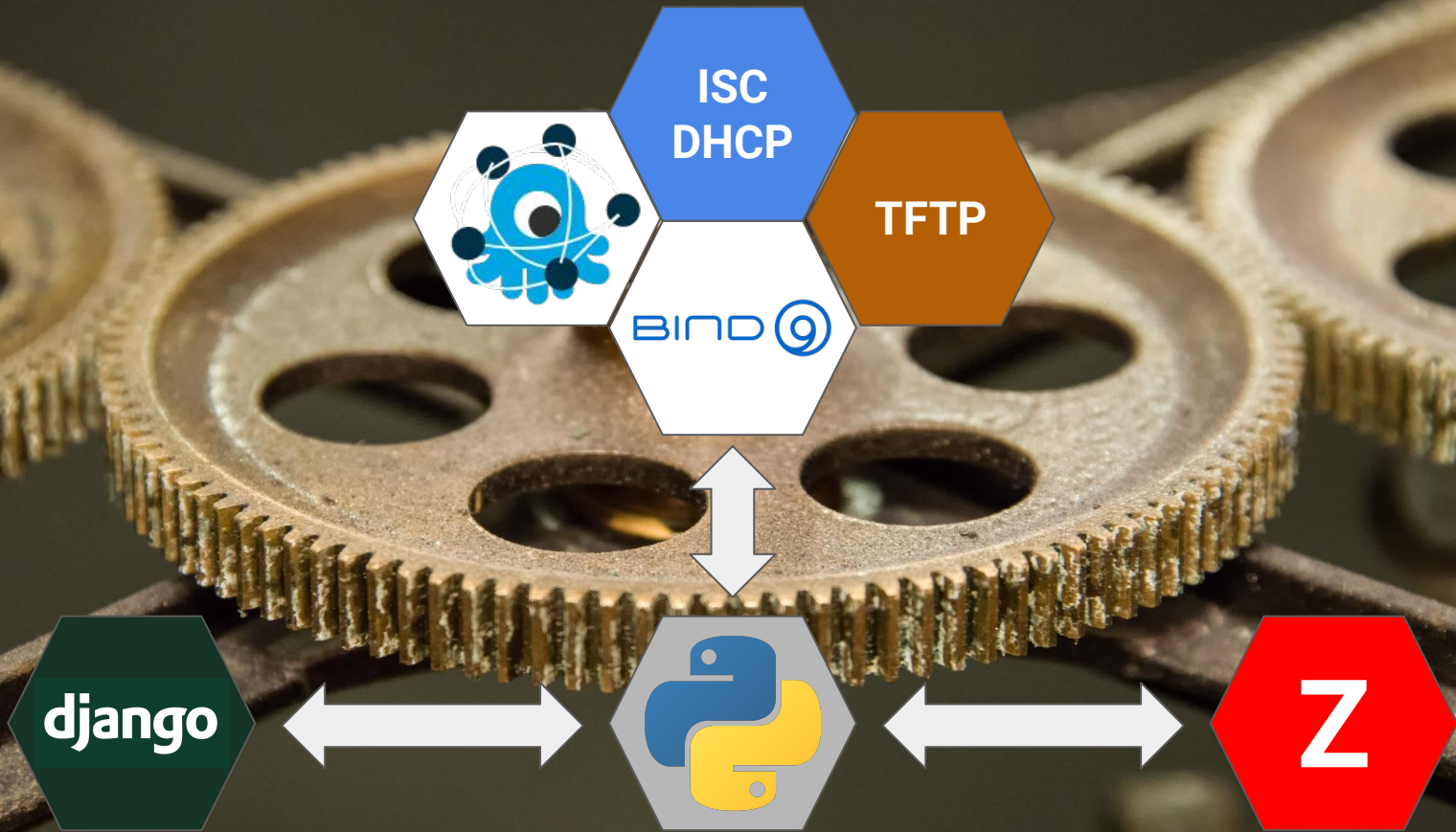

# Aggregates

| <input type="checkbox"/> Host | Name ▾                                                         | Last check          | Last value | Change  |
|-------------------------------|----------------------------------------------------------------|---------------------|------------|---------|
| ▾ Routers                     | <b>Aggregates::Metrics</b> (10 Items)                          |                     |            |         |
| <input type="checkbox"/>      | Aggr: Total number of Jasper sims registered for hosts in R... | 2019-09-26 14:15:12 | 509        |         |
| <input type="checkbox"/>      | Aggr: Total number of hosts in Routers                         | 2019-09-26 16:30:09 | 520        |         |
| <input type="checkbox"/>      | Aggr: Total monthly sim data usage of hosts in Routers         | 2019-09-26 16:30:13 | 2.23 GB    |         |
| <input type="checkbox"/>      | Aggr: Sim data bundle size in Routers (B)                      | 2019-09-26 16:25:05 | 100 GBytes |         |
| <input type="checkbox"/>      | Aggr: Number of hosts in Routers responding to ping            | 2019-09-26 16:30:11 | 516        |         |
| <input type="checkbox"/>      | Aggr: Number of hosts in Routers currently in maintenance      | 2019-09-26 16:30:14 | 2          |         |
| <input type="checkbox"/>      | Aggr: Cellular data bundle size in Routers (B)                 | 2019-09-26 16:25:04 | 100 GBytes |         |
| <input type="checkbox"/>      | Aggr: Average ping responsetime of hosts in Routers            | 2019-09-26 16:15:08 | 14.2ms     |         |
| <input type="checkbox"/>      | Aggr: Average ping loss of hosts in Routers                    | 2019-09-26 16:15:07 | 0.81 %     | -0.06 % |
| <input type="checkbox"/>      | Aggr: Average cellular RSSI of hosts in Routers                | 2019-09-26 14:15:06 | -91.94 db  |         |





# Housekeeping



# Maintenance

## Maintenance periods

Group all

Create maintenance period

| <input type="checkbox"/> Name ▲        | Type                 | Active since     | Active till      | State  | Description                                    |
|----------------------------------------|----------------------|------------------|------------------|--------|------------------------------------------------|
| <input type="checkbox"/> Maintenance   | With data collection | 2019-05-12 00:00 | 2025-12-08 00:00 | Active | Manual maintenance                             |
| <input type="checkbox"/> Offline       | With data collection | 2019-05-12 00:00 | 2025-12-08 00:00 | Active | Devices that have been Offline for a long time |
| <input type="checkbox"/> Predeployment | With data collection | 2019-05-12 00:00 | 2025-12-08 00:00 | Active | Predeployment maintenance                      |

Displaying 3 of 3 found

On host creation, host is removed when it has been online for a predefined period.

Host is placed in maintenance after 7 days of inactivity

Can be used manually by an engineer



# Cleanup Items

```
[zabbix@zabbix-server ~]$./itemcleanup.py 'Switches' 'Accesspoints'
'Routers' -v
Zabbix API version: 3.0.27
Inspecting 520 host(s)...
Disabling 29 item(s) on 3 host(s).
Enabling 0 item(s) on 516 host(s).
[zabbix@zabbix-server ~]$
```

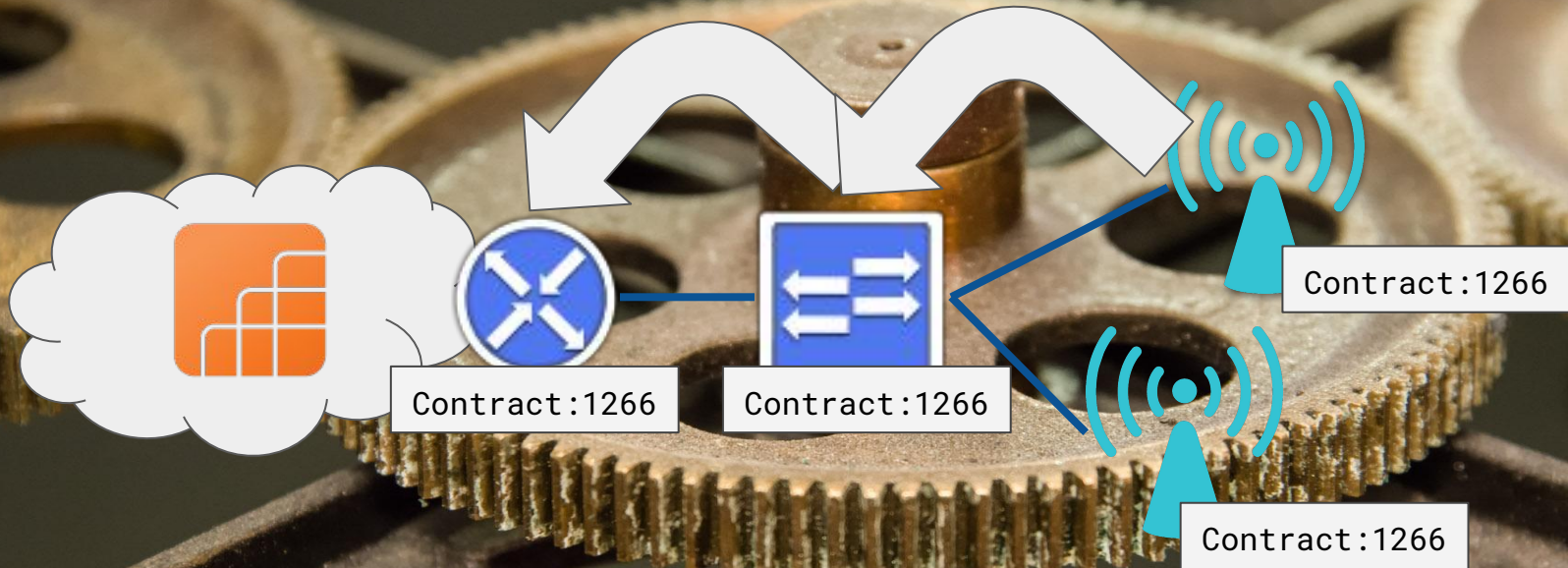



# Alerts

## DREMPELWAARDES

Stuur alarmbericht naar de onderstaande contactpersonen wanneer X procent van de filialen down zijn

- ✓ 10% filialen down
- 15% filialen down
- 25% filialen down
- 30% filialen down



User macro on  
aggregate host

## ONTVANGERS

| ENABLED                             | TYPE    | TARGET           |
|-------------------------------------|---------|------------------|
| <input checked="" type="checkbox"/> | Email ▾ | user@example.com |
| <input checked="" type="checkbox"/> | SMS ▾   | +31123456789     |
| <input checked="" type="checkbox"/> | Email ▾ | user@example.com |



Media assigned to  
'customer' user.

ontvanger toevoegen

# Reporting

```
[zabbix@zabbix-server zbxreporter]$./zbxreporter.py
usage: zbxreporter.py [-h] [--filtergroups [GROUPS [GROUPS ...]]]
 [--filtertemplates [TEMPLATES [TEMPLATES ...]]]
 [--filterhosts [HOSTS [HOSTS ...]]]
 [--filterresult [FILTEREXPRESSION [FILTEREXPRESSION ...]]]
 [--selectitems [ITEMS [ITEMS ...]]]
 [--selectinventory [INVENTORY [INVENTORY ...]]]
 [--selecthost [HOST [HOST ...]]]
 [--selectinterface [INTERFACE [INTERFACE ...]]]
 [--listproperties] [--listgroups] [--listtemplates]
 [--listitems] [--resolveitems] [--resolvevalues]
 [--timestamps] [--osm] [--mailto [MAILTO [MAILTO ...]]]
 [--mailtype MAILTYPE] [--mailsubject SUBJECT] [-H URL]
 [-U USERNAME] [-P PASSWORD] [-u] [-p] [-c CONFIGFILE]
 [-v VERIFY]
```



# Reporting

```
host serialno_a ifHCOutOctets[Fa0]

-rt01. retailstekker.net FC 0.0bps
-rt01. retailstekker.net FC 254.2Kbps
-rt01. retailstekker.net FC 0.0bps
-rt01. retailstekker.net FC 63.1Kbps
-rt01. retailstekker.net FG 544.0bps
-rt01. retailstekker.net FC 0.0bps
-rt01. retailstekker.net FC 204.2Kbps
-rt01. retailstekker.net FC 0.0bps
```

# Questions?



@RaymondKuiper



[nl.linkedin.com/in/raymondkuiper](https://nl.linkedin.com/in/raymondkuiper)



[github.com/q1x](https://github.com/q1x)



NETCO®